

Connecting solution

Sunmulon provide various connection way for your assembly work.

EH



3 type of Terminal Shape
 brings 5 connection way.

- Solder tab terminal #110

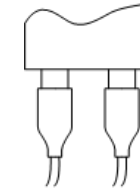
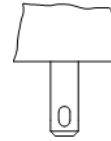

Solder Wire



#110 tab
 receptacle

Quick connection
 No soldering required



Socket

- PC board terminal

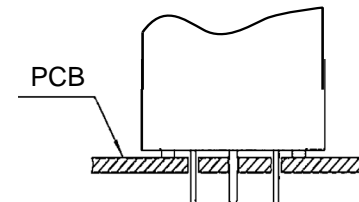

Soldering on PCB

- Connector

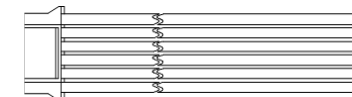

Wire Harness

Quick connection
 No soldering required

EH

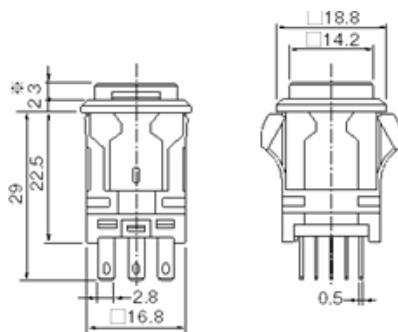

Contact Ratings :
(Resistive load)

AC125V, 250V 3A : Silver (Gold Plated) contacts
AC125V, DC30V 0.1A : Crossbar contacts



Electrical Life :

100,000 operations minimum: Silver (Gold Plated) contacts
100,000 operations minimum: Crossbar contacts





Mechanical Life :

2,000,000 operations minimum: Momentary
200,000 operations minimum: Alternate

Button Shape :

-  14.2mm Square, Dimple · Square
-  14.2 × 20.4mm Rectangle, Dimple · Rectangle

Illumination Type :

- Single Color**  Red, Green, Orange-Yellow, Super Blue, Super White, Super Green
- Dual Color**  Red · Green, Red · Super Blue, Red · Super White, Red · Super Green, Green · Orange-Yellow, Orange-Yellow · Red, Orange-Yellow · Super Blue, Super Blue · Super White, Super White · Super Green, Super Green · Super Blue
- Split-Face** 
- Spot**  Red, Green, Orange-Yellow

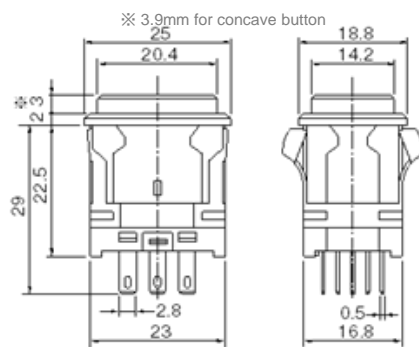

※ 3.9mm for concave button

Sunmulon Illuminated Push button Switch

Terminal variation

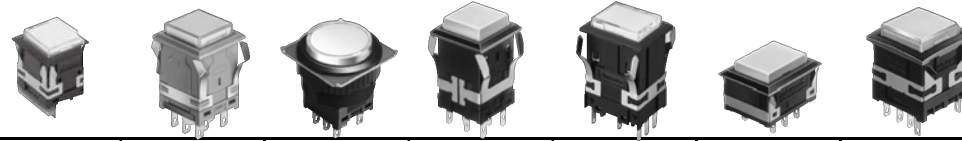

	CH	EH	EH-G	FH	SP	VH	XH
Solder terminal	○			○		○	
Solder tab terminal #110		○	○		○		○
PC board terminal	○	○	○		○	○	
Connector	○	○	○				
Socket	○	○	○	○	○	○	○
Easy wiring unit							○

[XH Easy wiring unit]

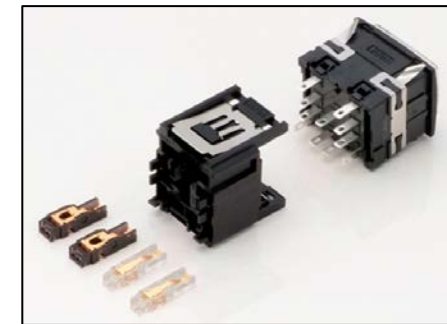

	AH	DH	HH	KC	KH	MH	RH	TA	TH	WH	YH
Solder terminal	○		○				○				
Solder tab terminal #110		○			○	○		○		○	○
PC board terminal			○	○	○	○	○		○		○



	KA	K2	K9
Surface mount terminal	○	○	○



CH



Button Shape

- 13.2mm Square
- 13.2 × 19.4mm Rect.
- 16mm Square
- 19mm Round





Illumination type

- Full-Face, Single color 
- Full-Face, Dual color 
- 2-Split-Face 

EH





- 14.2mm Square
- 14.2 × 20.4mm Rect.

- Full-Face, Single color 
- Full-Face, Dual color 
- 2-Split-Face 
- Spot Illumination 

EH-G



- 20.2mm Round
- 17mm Square

- Full-Face, Single color 
- Full-Face, Dual color 



FH



Button Shape

- 11.4mm Square
- 11.4 × 16.4mm Rect.

Illumination type

- Full-Face, Single color 
- Full-Face, Dual color 

SP





- 18.4 × 24.4mm Rect.

- Full-Face, Single color 
- Full-Face, Dual color 
- Full-Face, Multi color 
- Split-Face 

VH





- 12mm Square
- 12 × 17mm Rect.

- Full-Face, Single color 
- Full-Face, Dual color 

XH

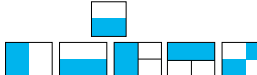

- 19mm Square
- 19 × 26mm Rect.

- Full-Face, Single color 
- Full-Face, Dual color 
- Split-Face 

SMT (Surface Mount Terminal) series





Button Shape



- 12mm Square
- 15mm Square
- 17.4mm Square



- 12mm Square
- 15mm Square

- 9mm Square

Illumination type

- Full-Face, Dual color 
- Full-Face, Multi color 

- Full-Face, Single color 
- Full-Face, Dual color 

- Full-Face, Single color 
- Full-Face, Dual color 

https://www.sunmulon.co.jp/english/d_load_e/pdf_e/ka_e.pdf

https://www.sunmulon.co.jp/english/d_load_e/pdf_e/k2_e.pdf

https://www.sunmulon.co.jp/english/d_load_e/pdf_e/k9_e.pdf

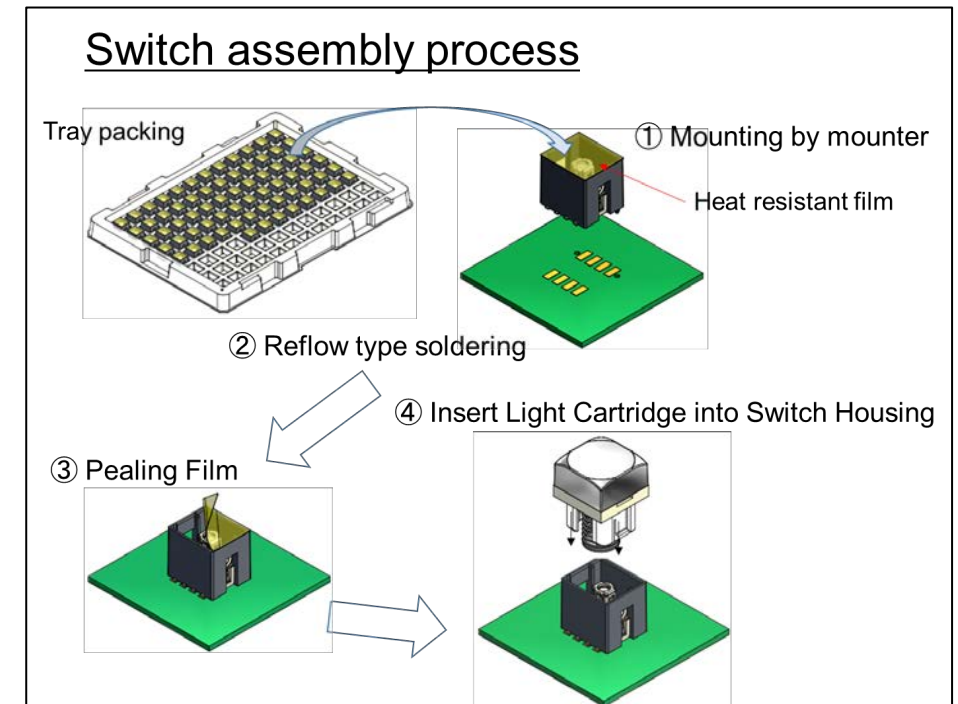

Sunmulon provide various connection way
for your assembly work.